

Explosionszeichnung

**Elektroherd mit Ofen
Serie Ready 700**



KBS Gastrotechnik GmbH - Johannes-Kepler-Str. 14 - 55129 Mainz

01110 (2.6kW)
220x220

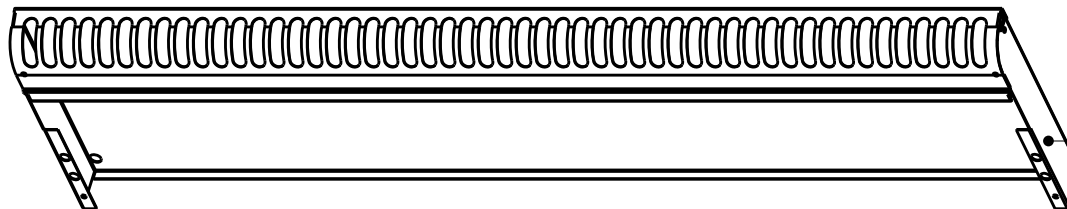
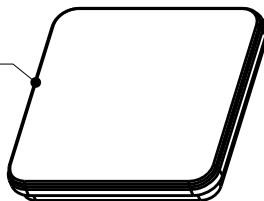

01107 (2.6kW) ø220
01108 (1.5kW) ø148
01670 (2kW) ø220

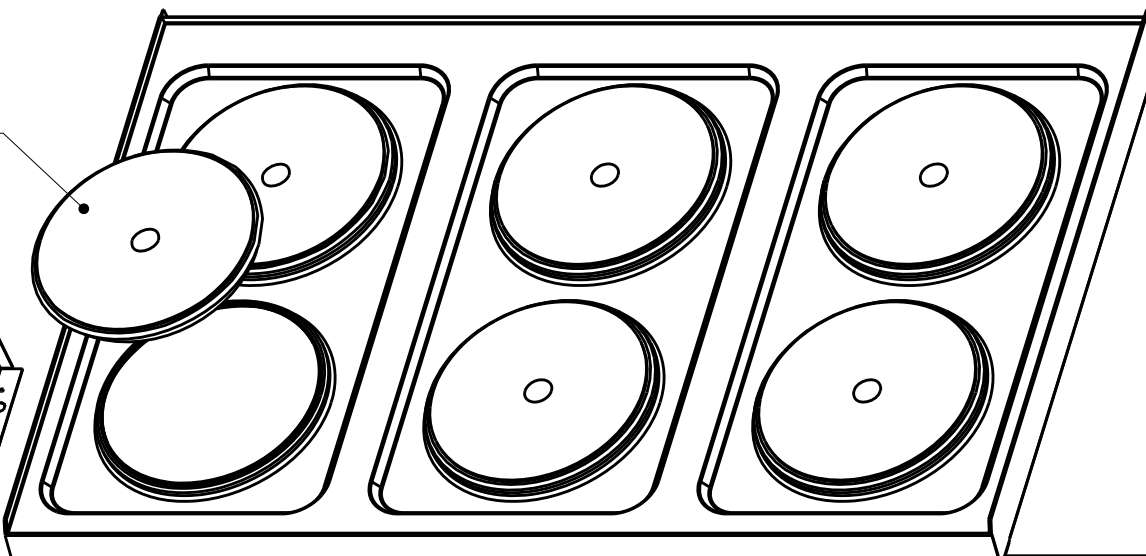

01050 (mod.350)
01051 (mod.700)
01052 (mod.1050)

01054

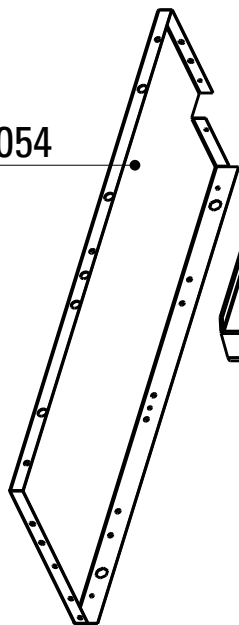

01053

00241 (PG 16)
01055 (PG 21)



01073



00291

01104 (mod.350)
01105 (mod.700)
01106 (mod.1050)

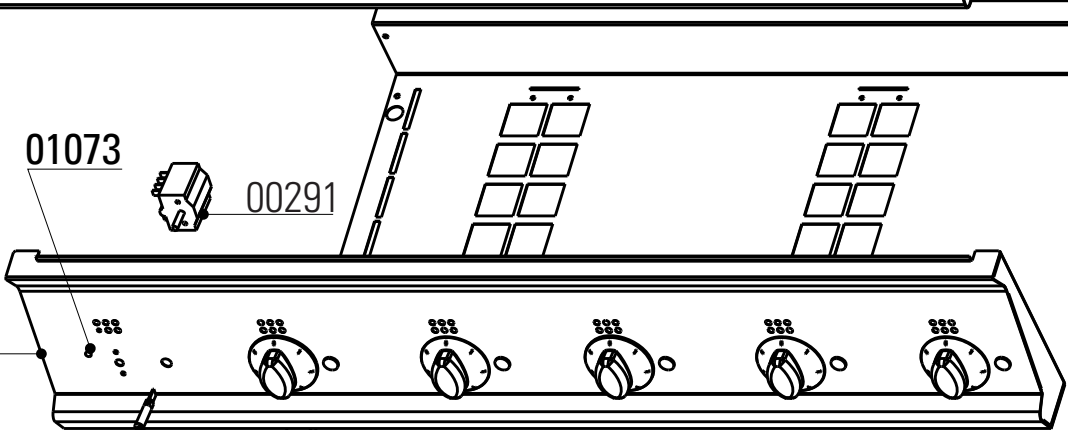

00052 - LAMP



00053 - GREEN



00311

00194

01109 - Blu
01330 - Grey

01101 (mod.350)
01102 (mod.700)
01103 (mod1050)

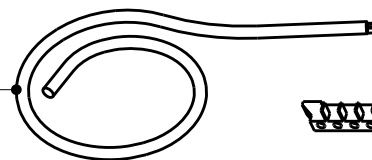

00018

Artic./Item	Descrizione/Description	Modello/Model
616074	CUCINA ELETTRICA 4 PIASTRE TONDE CON FORNO ELETTRICO VENTILATO GN1/1 4 ROUND HOT PLATES ELECTRIC RANGE WITH GN1/1 FAN ASSISTED ELECTRIC OVEN	PFR70V7/1

Cons./Recom.	Pos./Posit.	Ricambio/Replacement	
*	00291000	RC00291000	COMMUTATORE SWITCH
	00304000	RC00304000	MORSETTO EQUIPOTENZIALE COMP. EQUIPOTENTIAL CONNECTING BLOCK
	01051000	RC01051000	CAMINO 700 L7 FLUE 700 L7
	01107000	RC01107000	PIASTRA ELETTRICA ROUND 220 2600W 230V ROUND HOT PLATE
	02029000	RC02029000	MANOPOLA PCE NERA KNOB PCE
	02071000	RC02071000	MANOPOLA PCE GRIGIA UNDERKNOB RAL7001
	501	RC02028000	PORTA FORNO GN2/1 TECNO70 DOOR W/HANDLE
	502	RC02082000	MANIGLIA FORNO OVEN HANDLE
*	503	RC01610000	TERMOSTATO DI LAVORO FORNO WORKING THERMOSTAT OVEN L9
*	504	RC00070000	COMMUTATORE TRIFASE SWITCH
	507a	RC01835000	MANOPOLA PF NERA KNOB 60°-270°
	507a	RC02054000	MANOPOLA PF GRIGIA KNOB RAL7001
*	508	RC00052000	LAMPADA SEGN.NEON FASTON ARANCIO 230V SIGNAL NEON LAMP
*	509	RC01783000	PORTALAMPADA TRASPARENTE D10 TRANSPARENT LAMP HOLDER D10
*	510	RC01782000	LAMPADA SEGN.NEON FASTON VERDE 230V GREEN NEON LAMP 230V
	511	RC01068000	CERNIERA SX PORTA FORNO GN C/P.RULLINO LEFT HINGE
	512	RC00194000	MORSETTIERA FV 122 B CONNECTING BLOCK
	513	RC01055000	PRESSACAVO PG21 CON DADO CABLE GLAND WITH NUT
	514	RC00602000	PIEDE 1" 3/4 INOX FOOT
	515	RC01064000	ZOCCOLO FORNO L7 OVEN SOCLE L7
	517	RC01067000	CERNIERA DX PORTA FORNO GN C/P.RULLINO RIGHT HINGE
*	518	RC00305000	TERMOSTATO DI SICUREZZA SAFETY THERMOSTAT
*	522	RC01562000	RESISTENZA CIRCOLARE 2,5kW CIRCULAR HEATING ELEMENT

Artic./Item	Descrizione/Description	Modello/Model
616074	CUCINA ELETTRICA 4 PIASTRE TONDE CON FORNO ELETTRICO VENTILATO GN1/1 4 ROUND HOT PLATES ELECTRIC RANGE WITH GN1/1 FAN ASSISTED ELECTRIC OVEN	PFR70V7/1

Cons./Recom.	Pos./Posit.	Ricambio/Replacement	
523	RC01561000	MOTOVENTILATORE COMPLETO FORNO EL.VENT.	ELECTRIC VENTILATOR _VE7
524	RC02032000	SUPPORTO GRIGLIA FORNO EL.VENTILATO	OVEN GRID HOLDER
525	RC01826000	GUARNIZIONE TESSILE PER FORNO GN	TEXTILE GASKET FOR OVEN
526	RC01585000	PIOLINO SUPP.GRIGLIA FORNO EL.VENTILATO	PIN FOR OVEN RUNNERS SUPPORT

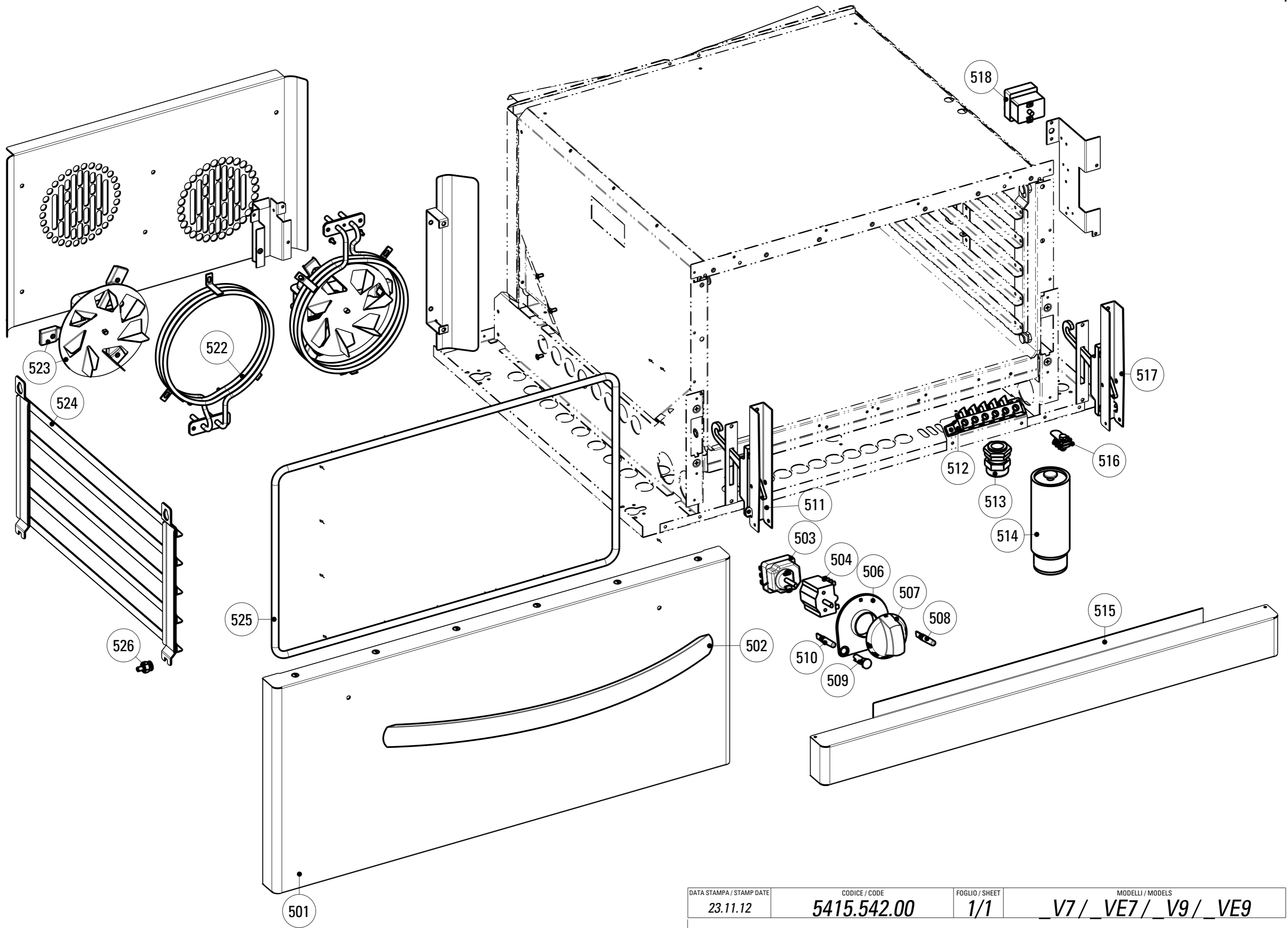

Artic./Item Descrizione/Description Modello/Model

616074 CUCINA ELETTRICA 4 PIASTRE TONDE CON FORNO ELETTRICO VENTILATO GN1/1
4 ROUND HOT PLATES ELECTRIC RANGE WITH GN1/1 FAN ASSISTED ELECTRIC OVEN **PFR70V7/1**

Cons./Recom.	Pos./Posit.	Ricambio/Replacement	
*	00291000	RC00291000	COMMUTATORE SWITCH
	00304000	RC00304000	MORSETTO EQUIPOTENZIALE COMP. EQUIPOTENTIAL CONNECTING BLOCK
	01051000	RC01051000	CAMINO 700 L7 FLUE 700 L7
	01107000	RC01107000	PIASTRA ELETTRICA ROUND 220 2600W 230V ROUND HOT PLATE
	02029000	RC02029000	MANOPOLA PCE NERA KNOB PCE
	02071000	RC02071000	MANOPOLA PCE GRIGIA UNDERKNOB RAL7001
	501	RC02028000	PORTA FORNO GN2/1 TECNO70 DOOR W/HANDLE
	502	RC02082000	MANIGLIA FORNO OVEN HANDLE
*	503	RC01610000	TERMOSTATO DI LAVORO FORNO WORKING THERMOSTAT OVEN L9
*	504	RC00070000	COMMUTATORE TRIFASE SWITCH
	507a	RC01835000	MANOPOLA PF NERA KNOB 60°-270°
	507a	RC02054000	MANOPOLA PF GRIGIA KNOB RAL7001
*	508	RC00052000	LAMPADA SEGN.NEON FASTON ARANCIO 230V SIGNAL NEON LAMP
*	509	RC01783000	PORTALAMPADA TRASPARENTE D10 TRANSPARENT LAMP HOLDER D10
*	510	RC01782000	LAMPADA SEGN.NEON FASTON VERDE 230V GREEN NEON LAMP 230V
	511	RC01068000	CERNIERA SX PORTA FORNO GN C/P.RULLINO LEFT HINGE
	512	RC00194000	MORSETTIERA FV 122 B CONNECTING BLOCK
	513	RC01055000	PRESSACAVO PG21 CON DADO CABLE GLAND WITH NUT
	514	RC00602000	PIEDE 1" 3/4 INOX FOOT
	515	RC01064000	ZOCCOLO FORNO L7 OVEN SOCLE L7
	517	RC01067000	CERNIERA DX PORTA FORNO GN C/P.RULLINO RIGHT HINGE
*	518	RC00305000	TERMOSTATO DI SICUREZZA SAFETY THERMOSTAT
*	522	RC01562000	RESISTENZA CIRCOLARE 2,5kW CIRCULAR HEATING ELEMENT

Artic./Item	Descrizione/Description	Modello/Model
616074	CUCINA ELETTRICA 4 PIASTRE TONDE CON FORNO ELETTRICO VENTILATO GN1/1 4 ROUND HOT PLATES ELECTRIC RANGE WITH GN1/1 FAN ASSISTED ELECTRIC OVEN	PFR70V7/1

Cons./Recom.	Pos./Posit.	Ricambio/Replacement		
	523	RC01561000	MOTOVENTILATORE COMPLETO FORNO EL.VENT.	ELECTRIC VENTILATOR _VE7
	524	RC02032000	SUPPORTO GRIGLIA FORNO EL.VENTILATO	OVEN GRID HOLDER
	525	RC01826000	GUARNIZIONE TESSILE PER FORNO GN	TEXTILE GASKET FOR OVEN
	526	RC01585000	PIOLINO SUPP.GRIGLIA FORNO EL.VENTILATO	PIN FOR OVEN RUNNERS SUPPORT