

# Bedienungsanweisung

## Gewerbekühlschrank **KU 407 2-G LED**

[Artikel-Nr.: 477600370]



# BOTTLE COOLER / WINE COOLER

MODEL:  
FKG 370

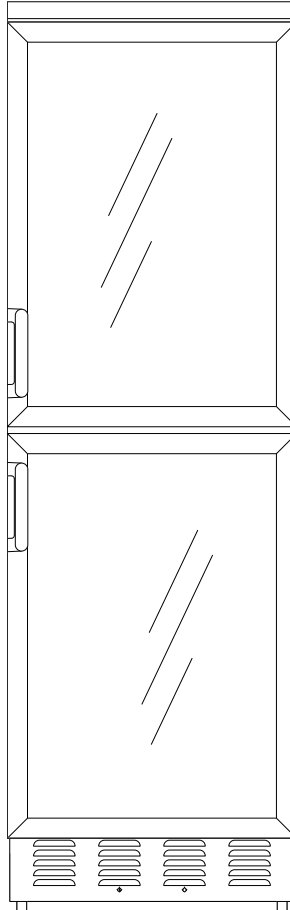

Please read these instructions carefully before putting the appliance into service. They are brief and contain only information which will help you to obtain the best performance from the appliance

Take care of all accessories supplied with the appliance.

## CONTENTS

1. Before starting the appliance.
2. How to use the appliance.
3. Maintenance.
4. Has the appliance stopped working?
5. Safety.
6. Technical data.
7. Installation.
8. Change of hinge side.
9. Lighting fixture.

### 1. BEFORE STARTING THE APPLIANCE

Check that the cabinet is undamaged. Please report any damage **immediately** to your dealer. Wash the cabinet and inner lining with a mild unscented detergent and wipe it dry. Do not use abrasive scouring powder, steel wool or similar. Connection to the electricity supply: See head 7 and 8.

### 2. HOW TO USE THE APPLIANCE

Operating panel. See fig. 5, page 4.

1. Thermostat knob.
2. Indicator for the connection to the electricity supply (green).
3. Switch for light.

The thermostat knob is adjustable from 0 (stop) to 7 (coldest). Find the position of the thermostat which gives you the desired temperature. Start at position 4.

### Defrosting

The evaporator is automatically defrosted. The defrost water is led to a tray on top of the compressor where it evaporates.

### 3. MAINTENANCE

Only use an unscented detergent when cleaning the cabinet inside.

You may remove the top panel and wash it when cleaning the cabinet inside.

Switch off the appliance and pull out the plug when cleaning the cabinet.

The skirting board can be removed to facilitate a vacuum-cleaning of the floor. See fig. 1, page 5.

To make the cooling system work at its optimum it is necessary from time to time to clean the wire condenser and the compressor at the back of the cabinet by means of a brush or a vacuum cleaner. Remember to clean the drain.

### 4. HAS THE APPLIANCE STOPPED WORKING?

Before calling a repairman, check that

- The plug is properly plugged into the wall socket.
- The fuse is intact.
- The power has not been cut off.
- All controls are correctly set.
- Switch off the cabinet for 15 minutes (for instance at the thermostat). Switch it on again and after 5 minutes check whether frost has formed on the evaporator.
- Do not open the cabinet when unnecessary.

### 5. SAFETY

**Do not** store explosive substances in the refrigerator section, such as gas, cigarette lighters, petrol, ether or similar. Scrapped cabinets may become dangerous to children at play. Therefore, remove the doors or place the scrapped cabinet in such a way that children cannot enter it. Never store liquids with carbon dioxide in the freezing section.

### 6. TECHNICAL DATA

This appliance meets the provisions of the following directives: 89/336/EEC (electromagnetic compatibility), 73/23/EEC (electrical equipment designed for use within certain voltage limits) as amended. The rating plate, which is placed inside the appliance (see fig. (6) page (4)), provides various technical information as well as type and serial number.

## 7. INSTALLATION

See drawings page 5.

Install the cabinet in a dry place and so that it is not exposed to direct sunlight or any other source of heat.

Place the cabinet in a level position. This is easily achieved by adjusting the adjustable feet at the front edge of the base. The cabinet may not rest against a wall on its hinged side. When placing the cabinet on a carpet or on a wooden floor you should adjust it once more after some time as the cabinet might settle in soft foundations. If you want to build the appliance into a cupboard you must consider 3 factors:

1. There must be space above the appliance in order to make the cooling system work satisfactorily. - Fig. 2a, page 6.
2. When the door is opened the appliance takes up more room in the width and therefore the door must either be placed outside the cupboard or there must be a space of at least 1,5 cm at the hinge side. - Fig. 2b and 2c, page 6.
3. The distance to the wall at the hinge side must be of a sufficient size. - Fig. 2d, page 6.

Furthermore is it possible to build together two appliance. - Fig. 3, page 6.

If the wine cooler is to be placed next to another unit, a 25 mm gap must be left.

It is safest to place the earthed wall socket above the appliance and at least 2.0 m above the floor. Any local installation rules for appliances of this kind must be observed.

During a storm the electricity supply might be cut off.

You should be aware of this when installing the appliance in weekend cottages or elsewhere where you would not immediately observe that the power has been cut off. Construction and details in the accessories are subject to alteration without previous notice.

## 8. CHANGE OF HINGE SIDE

Follow the instructions below if you wish to install the door hinges at the opposite side. See the drawings on page 7.

Dismantle the top panel cover - fig 1 and 2.

Dismantle the top hinge. To be used later as bottom hinge at the opposite side - fig 3.

Dismantle the door and its bushing.

Dismantle the bottom hinge - fig. 6.

Place the tension disk and the counter nut for the hinge pivot on the new bottom hinge.

Mount the door anew.

Tighten the counter nut at the bottom.

Tighten up all nuts.

Mount anew top panel cover and skirting board cover

## 9. LIGHTING FIXTURE

See the drawing on page 7.

1. Pull the screen to the left.

2. Pull down the right side of the screen and take it out.

- Remove the strip - possibly with text - by pulling it out of the tracks along the whole length of the profile.

- The fluorescent tube can be replaced.

The mounting is performed in reverse order.

The glow switch can be replaced without removing the screen.

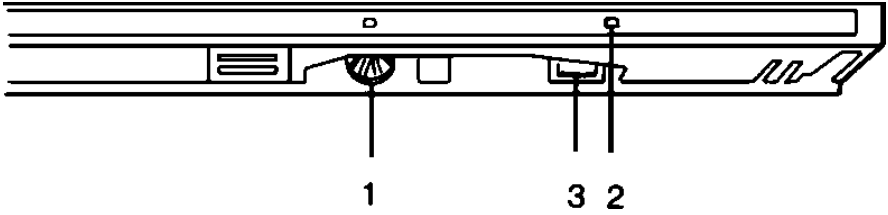

Fig. 5

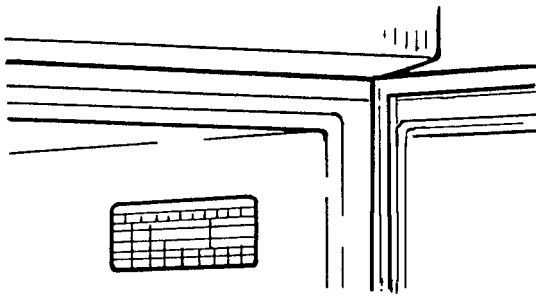

Fig. 6

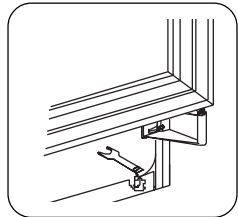
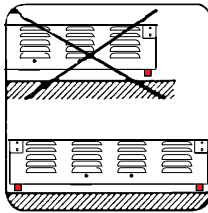
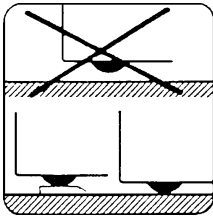
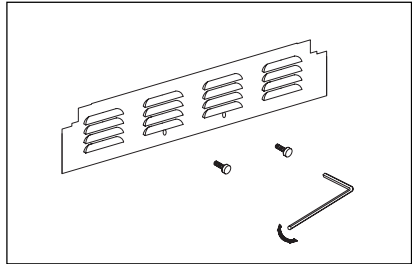
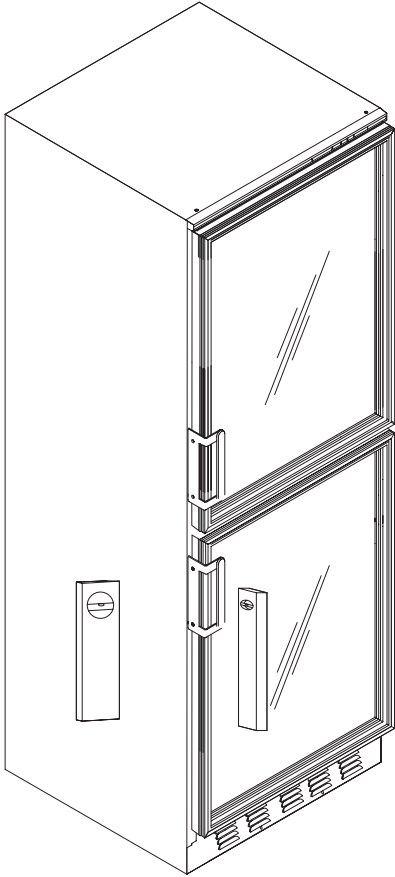

Fig. 1

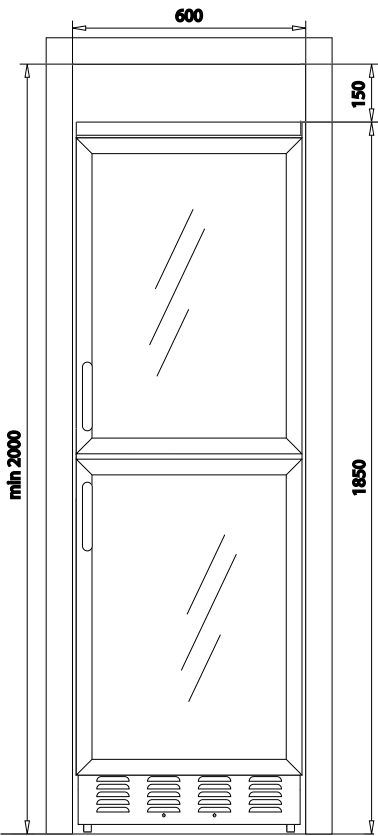

Fig. 2A

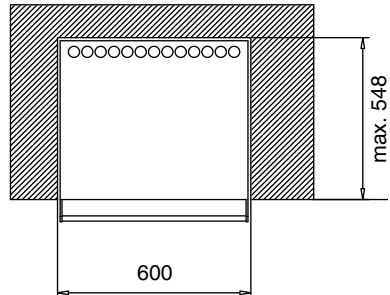

Fig. 2B

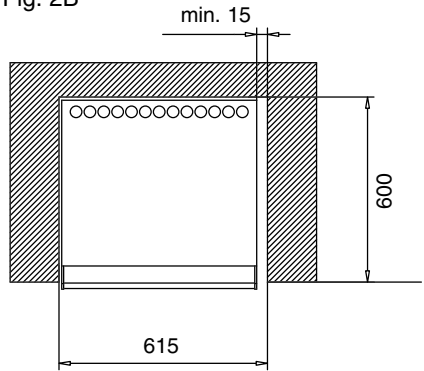

Fig. 2C

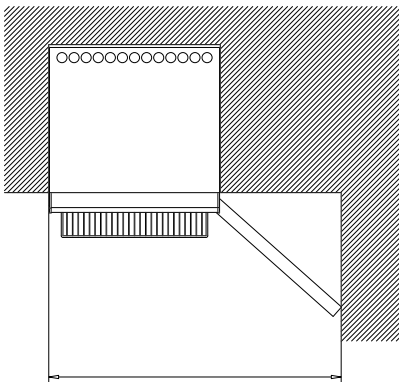

Fig. 2D

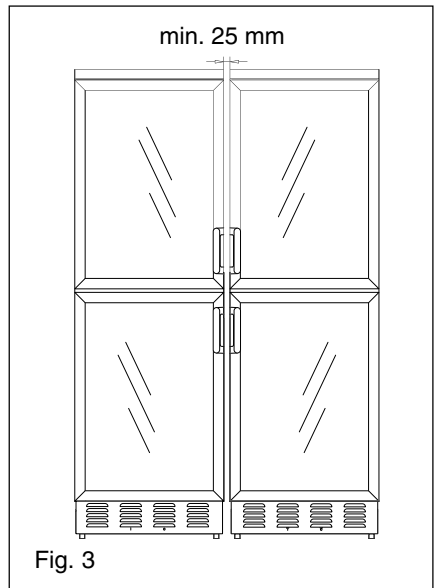
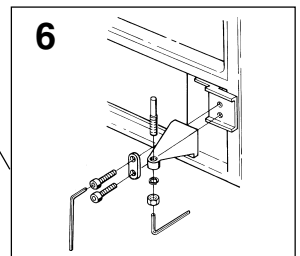
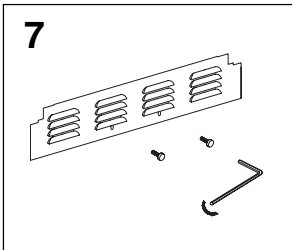
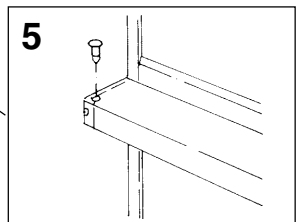
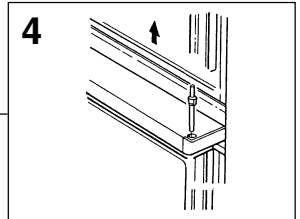
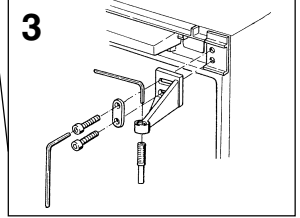
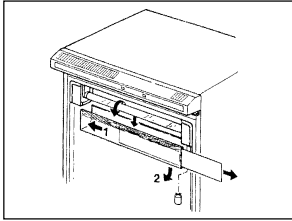
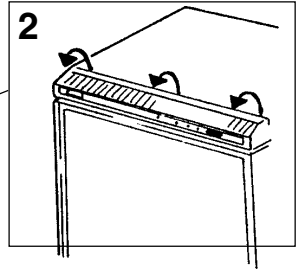
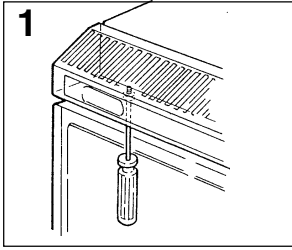

Fig. 3

# CHANGE OF HINGE SIDE









[www.nordcap.de](http://www.nordcap.de)

**Finanzen / Service**

**28307 Bremen**

Thalenhorststraße 15  
Tel. +49 421 48557-0  
Fax +49 421 488650  
[bremen@nordcap.de](mailto:bremen@nordcap.de)

**Vertrieb Ost**

**12681 Berlin**

Wolfener Straße 32/34, Haus K  
Tel. +49 30936684-0  
Fax +49 30936684-44  
[berlin@nordcap.de](mailto:berlin@nordcap.de)

**Vertrieb West**

**40699 Erkrath**

Max-Planck-Straße 30  
Tel. +49 211 540054-0  
Fax +49 211 540054-54  
[erkrath@nordcap.de](mailto:erkrath@nordcap.de)

**Vertrieb Nord**

**21079 Hamburg**

Großmoorbogen 5  
Tel. +49 40 766183-0  
Fax +49 40 770799  
[hamburg@nordcap.de](mailto:hamburg@nordcap.de)

**Vertrieb Süd**

**55218 Ingelheim**

Hermann-Bopp-Straße 4  
Tel. +49 6132 7101-0  
Fax +49 6132 7101-20  
[ingelheim@nordcap.de](mailto:ingelheim@nordcap.de)